

# AL4000 SERIES 100mm chart MULTI-POINT TYPE HYBRID MEMORY RECORDER



AL4000 series is a hybrid recorder which employs bright and clear, easy to view LCD display. Measuring value display is prepared as 1 point display, multi-points simultaneous display and digital display + bar graph display. Various measuring and recording settings can be easily done by front key switch and confirmed by LCD digital display.



## ■FEATURES

### ●Corresponds to SD card

Equipped with SD card (sold separately) and it can record data, read and write setting value.

### ●Full multi range

Equipped with DC voltage 10 kinds, T/C 36 kinds, RTD 12 kinds, in total 58 kinds. Easily set the range per channels.

### ●Easy data management by communication interface

Provided with USB port and connect with PC directly. RS232C, RS422A, RS485 and Ethernet communication interface is optionally prepared. When Ethernet is selected, settings from the web and E-mail alarm notification are added.

### ●Package Software attached

By Data acquisition software, the use of application expands from recording/management to information processing.

\*Optional communication interface required.

Data analysis software can replay display, wave process, editing and trend display.

Parameter setting software can manage the setting information on PC.

### ●Standard alarm display/ Printing function

Set 4 types of alarm per each input points. When alarm occurs, status display "ALM" flashes and measuring value flashes at LCD operation screen.

### ●Chart end detection function available

Can set the alarm operation when chart end is detected.

### ●Various programming function

Process the measured data by programming setting and displayed/recorded data of each channels are shown as programmed result data.

### ●SD card playback function (option)

By replaying the saved data files in SD card, you can record or printing back to the chart paper.

## ■MODELS

AL47□□-□□-□□N□

### Input point

06 : 6 points

### Communication interface (option)

N : None  
E : Ethernet  
R : RS232C  
A : RS422A/RS485  
Q : RS232C+RS485  
C : RS422A/RS485+RS485  
G : Ethernet + RS422A/RS485 +RS485  
F : Ethernet + RS422A/RS485 +RS485  
+ Low-order communications

### Alarm output / remote contacts (option)

0 : None  
2 : Mechanical relay 2 points ('a' contact)  
4 : Mechanical relay 4 points ('c' contact) + remote contact 5 points  
A : Mechanical relay 6 points ('a' contact) + remote contact 5 points

### Power supply

A : 100-240V AC

### Carrying handle and feet (option)

N: None  
T: With carrying handle and feet

### For OP/SP

N: None  
P: SD card playback

NAME

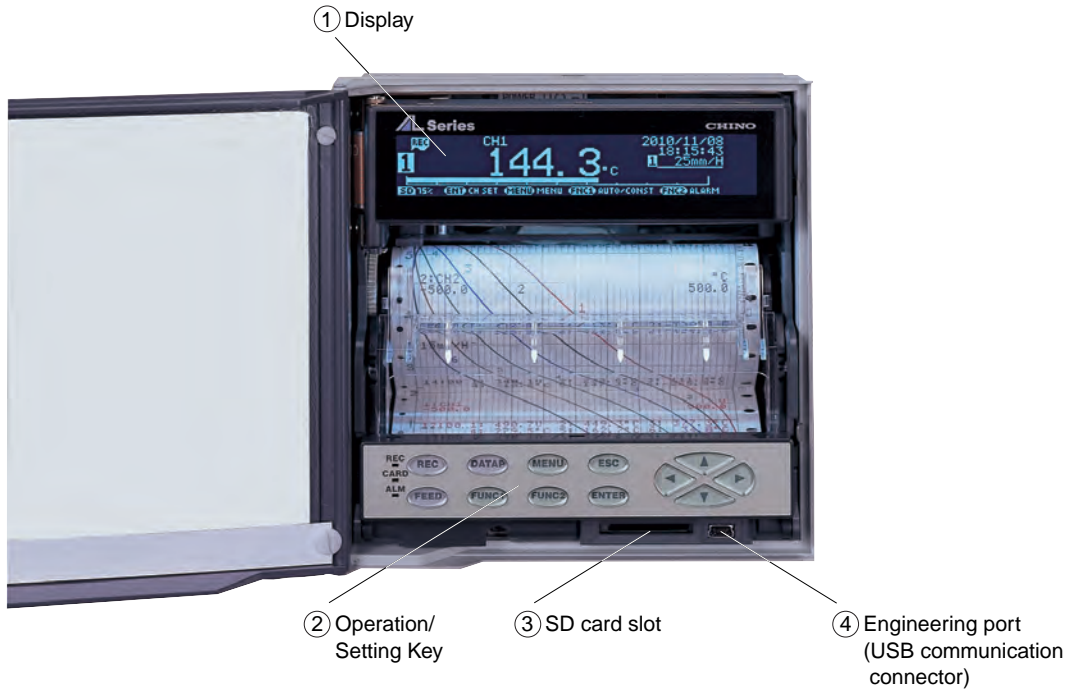

1. Graphic LCD display

Display measured data by digital display and analog indication by bar graph display.

● 1 point display



● 1 point display + bar graph display



● 6 points simultaneous display



2. Front key switch

Setting contents can be easily registered by front key switch.

Press **Menu** key and menu screen (list of setting items) will be displayed to graphic LCD.



3. SD card slot

Save measured data to SD card by designated interval (Fastest 6 points: 1sec). Also, register measuring / recording condition such as range, scale, chart speed and when required, setup the unit by registered conditions.

By using optional playback function you can perform the trace printing, digital recording / printing on the chart paper replaying the saved data files.

4. Prepare engineering port at the front

Connect with PC by mini-USB cable\*. By attached setting software, you can set or change the parameter by PC.

\*Purchase commercialized product separately.



5. White LED chart illumination

Set ON/OFF/AUTO (OFF after no operation for 3 minutes).

## RECORDING EXAMPLE

### Periodic data printing

Record the data over trace printing by arbitrary interval.

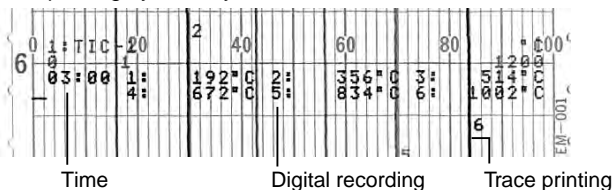

### List printing

Print setting data such as range, scale, etc. for each channel.

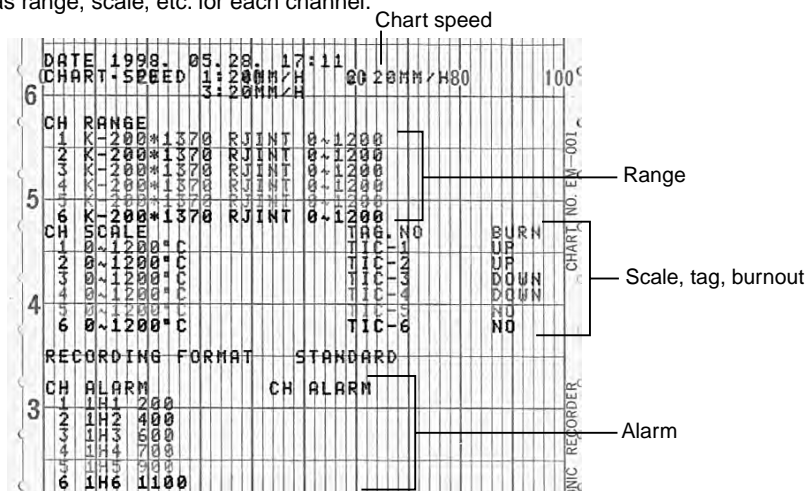

### Data print

When the latest data is required, trace printing will stop and record.

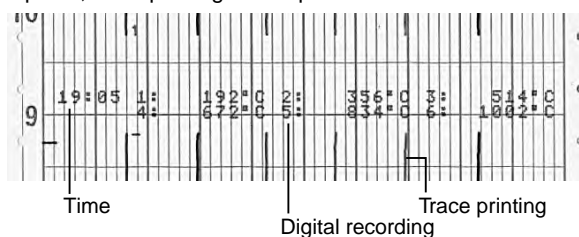

### Alarm printing

When alarm activates/reset, prints time, channel no., alarm type and alarm no.

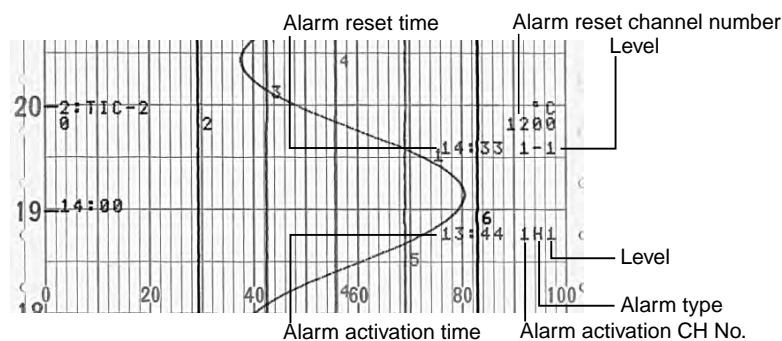

### SD card playback function (option)

By replaying the saved data files in SD card, you can record or printing back to the chart paper. It can reply even if the chart paper data is lost due to paper jam or no recording ink.

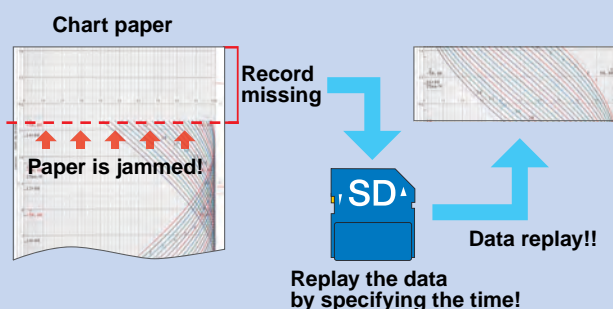

# AL4000 SERIES

## INPUT SPECIFICATIONS

Measuring points: 6  
 Input types: DC voltage ---  $\pm 3.8\text{mV}$ ,  $\pm 7.6\text{mV}$ ,  $\pm 9.0\text{mV}$ ,  
 $\pm 200\text{mV}$ ,  $\pm 500\text{mV}$ ,  $\pm 1\text{V}$ ,  
 $\pm 5\text{V}$ ,  $\pm 10\text{V}$ ,  $\pm 20\text{V}$ ,  $\pm 50\text{V}$   
 DC current --- Max 50mA by external shunt resistor  
 (100 $\Omega$ , 250 $\Omega$ ) (sold separately)  
 Thermocouple ---  
 K, E, J, T, R, S, B, N, U, L,  
 W-WRe26, WRe5-WRe26,  
 PtRh40-PtRh20, NiMo-Ni,  
 CR-AuFe, Platinel II, Au/Pt  
 Resistance thermometer ---  
 Pt100, old Pt100, JPt100, Pt50,  
 Pt-Co  
 Accuracy ratings: Refer to the table of measuring  
 range/accuracy ratings/display resolution  
 Measuring interval: 1 second / 6 points  
 Input resolution: About 1/40,000 or better (converted to  
 reference range)  
 Reference junction compensation accuracy:  
 At ambient temperature:  $23^{\circ}\text{C} \pm 1^{\circ}\text{C}$   
 K, E, J, T, N Platinel II ---  
 $\pm 0.5^{\circ}\text{C}$  or EMF 20 $\mu\text{V}$ , whichever  
 greater  
 Other than above ---  
 $\pm 1.0^{\circ}\text{C}$  or EMF 40 $\mu\text{V}$ , whichever  
 greater  
 Burnout: Burnout detection function for thermocouple  
 input and RTD input. Upper burnout, lower  
 burnout or burnout disabled is selectable for  
 each input.  
 Maximum common mode voltage:  
 30V AC/60V DC  
 Common mode rejection ratio:  
 130dB or more (50/60Hz)  
 Normal mode rejection ratio:  
 50dB or more (50/60Hz)  
 Terminal board: Removable when wiring.

## DISPLAY SPECIFICATIONS

Analog display: LCD bar graph 100mm  
 Digital display: Monographic type LCD  
 (Backlight AUTO / Always ON settable)  
 Dots: 240 x 48 dots  
 Display area: 106 x 16mm  
 Display item: All channels simultaneous display,  
 year/month/day, hour/minute, alarm activate  
 channel, chart speed display of measuring value.  
 Status display: REC, CARD, ALM

## ALARM DISPLAY

Alarm display: Status display "ALM" flash, measuring value  
 flash at operation screen  
 Alarm types: Absolute alarm, differential alarm, rate-of-  
 change alarm, FAIL, calendar timer, chart end.  
 Alarm settings: Individual settings, Max 4 levels/channel  
 Alarm output: Mechanical relay 2 or 6 points ('a' contact)  
 Mechanical relay 4 points ('c' contact)

## STANDARDS

CE marking: EN61326-1  
 EN61010-1  
 EN61010-2-030  
 \*Under EMC test condition, variation in  
 indication value is  $\pm 20\%$  or  $\pm 2\text{mV}$  at maximum,  
 whichever is larger.  
 UL: UL61010-1 2nd edition  
 CSA (C-UL): CAN/CSA C22.2 No.61010-1

## RECORDING SPECIFICATIONS

Dotting interval: 5 seconds/point, 3 seconds/point  
 Interlock to chart speed  
 Recording method: Wire-dot type 6-color ribbon  
 Record/Printed color:

Trace printing (default colors)

Channel no.	1	2	3
Color	Red	Black	Blue
Channel no.	4	5	6
Color	Green	Brown	Purple

Digital recording

Periodic data printing	Repetition of red, black, blue, green, brown and purple
Alarm printing	Activate: Red, Reset: Green
List printing	Black (channel each items color are same as trace printing color)

Chart paper: Fan-fold type  
 Total width 114mm, total length 10m, effective  
 chart width 100mm  
 Chart speed: 1 to 1500mm / h, in 1mm/h increments  
 (12.5mm / h can be set exceptionally)  
 Periodic data printing:  
 Digital printing is added to trace printing at  
 month / day, time, channel no., data, unit  
 Interval (hour/time) arbitrary setting.  
 When required, interrupt trace printing and  
 digital print time and measuring value.  
 Alarm printing: Alarm activated --- Time, channel no., alarm  
 type and level  
 Alarm reset --- Time, channel no., alarm level  
 Memory capacity --- Max. 48 data  
 List printing: When required, interrupt trace printing and print  
 date, chart speed and setting information of  
 each channel.  
 Message printing: Print when required  
 Up to 15 characters/message, register up to 20  
 characters.  
 ON/OFF of display and recording:  
 Select ON / OFF of display per each channel,  
 trace recording to chart, digital recording to  
 chart, recording to SD card  
 Subtract printing: Record difference between reference channel  
 and measuring value or between reference  
 value (set value) and measuring value.  
 Zone printing: 2 divisions  
 Compressed/Expanded printing:  
 Range limit is made non-linear and specific  
 chart recording lower/upper limit is shrunk or  
 expanded.  
 Automatic range shift printing:  
 Recording range is shifted automatically to  
 another set range when measured value  
 exceeds the current range. Overlap function  
 available.  
 Skip function: No display or printing of channels of which  
 ranges are not set.

## CONNECTIVITY

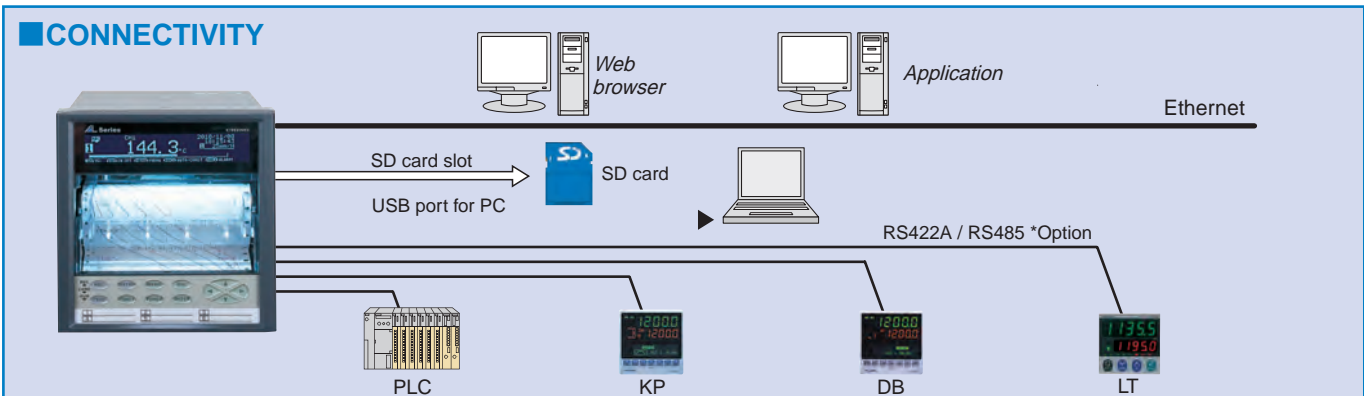

## GENERAL SPECIFICATIONS

Rated power voltage: 100 to 240VAC, 50/60Hz

Maximum power consumption: Max 40VA  
100V AC balanced: 20VA,  
240V AC balanced: 27VA

Normal operation condition:  
Ambient temperature range: 0 to 50°C (20 to 65%)  
Ambient humidity range: 20 to 80%RH (5 to 40°C)  
Power voltage: 90 to 264V AC  
Power frequency: 50/60Hz ±2%  
Attitude: forward tilting 0°, backward tilting 0 to 30°, left/right 0 to 10°

Case material: Door --- Aluminum die-casting  
Front panel --- Glass  
Case --- Cold-rolled steel plate

Case color: Door --- Black (equivalent of Munsell N3.0)  
Glass --- Clear and colorless  
Case --- Gray (equivalent of Munsell N7.0)

Mounting: Panel mounting  
Weight: About 3.0kg  
Terminal screw: Power terminal, Protective conductor terminal --- M4.0  
Measuring input terminal, alarm output terminal  
Remote contact terminal --- M3.5  
Communication terminal --- M3.0

## OPTIONS

Remote contact: By external relay contact signal (digital contact: short or open), you can select chart speed or data printing  
Input points: 5 points  
Input signal: Digital contact signal or open collector signal  
Exterior output: 5V DC/2mA  
Function: 1. Record start/stop  
2. Chart speed 3-speed switch  
3. Data printing  
4. List printing  
5. Message printing  
6. Operation record (Record ON/OFF condition to the designate location by bar line)  
7. Integration/F value reset  
8. Memory card (record start/stop)  
9. Alarm output rest  
10. Time correction

Alarm output: Mechanical relay ('a' contact) 2 points, 6 points  
Max. load 100 to 240VAC 0.2A  
30V DC 0.2A  
Min. load 5V DC 10mA  
Mechanical relay ('c' contact) 4 points  
Max. load 100 to 240VAC 0.2A  
30V DC 0.2A  
Min. load 5V DC 10mA

Communication interface: RS232C, RS422A, RS485, Ethernet

Low order communication: This instrument functions as host unit and reads data from the units\* connected as low order unit complying with the set parameter content. The data is to be displayed and recorded as host unit data. Use COM2 port (RS485) to connect with the low order units.  
To write the measured/ calculated data of this instrument to the low order unit (PLC) is also available.  
\*CHINO products and some of PLC (MELSEC, SYSMAC)

SD card playback: This function is to perform trace recording of measured value, digital recording/printing of time, time line and maximum/minimum chart record, etc. on the chart paper by using the data files of measured values saved in SD card.  
To perform the playback recording/printing, select desired files and specify a time range.  
Dot-printing is to be performed every 0.05mm as chart is fed, if any measured value data exists in the equivalent time scale.

## MEASURING RANGES/ACCURACY RATING/DISPLAY RESOLUTION

Input type	Measuring range	Reference range	Accuracy ratings	Display resolution	
DC voltage	mV	-13.8 to 13.8mV	±13.8mV	±0.1% ±1digit	10μV
		-27.6 to 27.6mV	±27.6mV		10μV
		-69.0 to 69.0mV	±69.0mV		10μV
		-200 to 200mV	±200mV		100μV
		-500 to 500mV	±500mV		100μV
	V	-1 to 1V	± 1V		10mV
		-5 to 5V	± 5V		10mV
		-10 to 10V	± 10V		10mV
		-20 to 20V	± 20V		10mV
		-50 to 50V	± 50V		10mV
Thermocouple	K	-200 to 300°C	±13.8mV	±0.1% ±1digit	0.1°C
		-200 to 600°C	±27.6mV		0.1°C
		-200 to 1370°C	±69.0mV		1 °C
	E	-200 to 200°C	±13.8mV		0.1°C
		-200 to 350°C	±27.6mV		0.1°C
	J	-200 to 900°C	±69.0mV		1 °C
		-200 to 250°C	±13.8mV		0.1°C
		-200 to 500°C	±27.6mV		0.1°C
	T	-200 to 1200°C	±69.0mV		1 °C
		-200 to 250°C	±13.8mV		0.1°C
		-200 to 400°C	±27.6mV		0.1°C
	R	0 to 1200°C	±13.8mV		1 °C
		0 to 1760°C	±27.6mV		1 °C
	S	0 to 1300°C	±13.8mV		1 °C
		0 to 1760°C	±27.6mV		1 °C
	B	0 to 1820°C	±13.8mV		1 °C
		-200 to 400°C	±13.8mV		0.1°C
	N	-200 to 750°C	±27.6mV		0.1°C
		-200 to 1300°C	±69.0mV		1 °C
	U	-200 to 250°C	±13.8mV		0.1°C
		-200 to 500°C	±27.6mV		0.1°C
	L	-200 to 600°C	±69.0mV		0.1°C
		-200 to 250°C	±13.8mV		0.1°C
	W-WRe26	-200 to 500°C	±27.6mV		0.1°C
		-200 to 900°C	±69.0mV		1 °C
	WRe5-WRe26	0 to 2315°C	±69.0mV		1 °C
		0 to 290°C	±13.8mV		0.1°C
	NiMo-Ni	0 to 600°C	±27.6mV		0.1°C
0 to 1310°C		±69.0mV	1 °C		
Platinel II	0 to 350°C	±13.8mV	0.1°C		
	0 to 650°C	±27.6mV	0.1°C		
PtRh40-PtRh20	0 to 1390°C	±69.0mV	1 °C		
	0 to 1880°C	±13.8mV	±0.2% ±1digit	1 °C	
CR-AuFe	0 to 280 K	±6.9mV	0.1 K		
	0 to 1000°C	±27.6mV	0.1°C		
Au/Pt	-140 to 150°C	160Ω	±0.1% ±1digit	0.1°C	
	-200 to 300°C	220Ω		0.1°C	
Pt100	-200 to 649°C	340Ω		0.1°C	
	-200 to 850°C	400Ω		0.1°C	
Old Pt100	-140 to 150°C	160Ω		0.1°C	
	-200 to 300°C	220Ω		0.1°C	
JPt100	-200 to 649°C	340Ω		0.1°C	
	-200 to 300°C	220Ω		0.1°C	
Pt50	-200 to 649°C	340Ω		0.1°C	
	-200 to 649°C	220Ω		0.1°C	
Pt-Co	4 to 374K	220Ω	±0.15% ±1digit	0.1 K	

Note: The accuracy ratings are converted into the measuring range under reference condition. Thermocouple input does not contain reference junction compensation accuracy.

K, E, J, T, R, S, B, N : IEC584(1977, 1982), JIS C 1602-1995, JIS C 1605-1995  
W-WRe26, NiMo-Ni, Platinel II, PtRh40-PtRh20, CR-AuFe, Au/Pt : ASTM E1751  
WRe5-WRe26 : ASTM E988 U, L : DIN43710-1985  
Pt100 : IEC751(1995), JIS C 1604-1997  
Old Pt100 : IEC751(1983), JIS C 1604-1989, JIS C 1606-1989  
JPt100 : JIS C 1604-1981, JIS C 1606-1986, Pt50 : JIS C 1604-1981 Pt-Co : CHINO

## ACCESSORIES

SD Card	512MB	Model : RZ-SMC512
	1GB	Model : RZ-SMC1G
	2GB	Model : RZ-SMC2G

## APPLICATION SOFTWARE (standard attached)

### Data Acquisition Software

You can acquire data easily to your PC.

\*Optional communication interface required

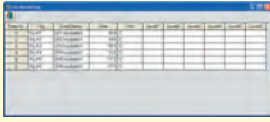

List Data Screen

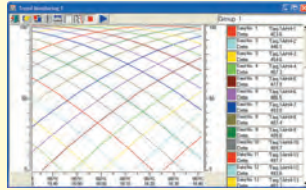

Trend Data Screen

### Parameter Setting Software

Control the setting information at PC by using communication interface or USB port (standard equipped)

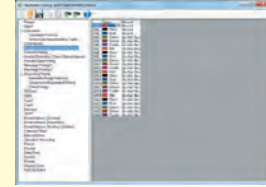
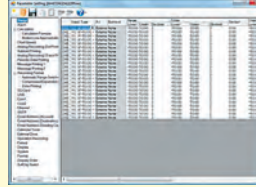

### Data Analysis Software

Open the binary file recorded in the SD card, replay display and edit the trend of acquired data file.

## TERMINAL ARRANGEMENT

### Alarm relay output (6 points 'a' contact) + remote contacts and communication interface

Communication terminal \*RS232C and RS422A/485 are specified on purchase.

	1	2	3	4	5	6	7	8
COM1	RS232C			SG	SD		RD	
	RS422A			SG	SDA	SDB	RDA	RDB
*	RS485			SG	SA	SB	SA	SB
COM2	RS485	SA	SB	SG				

Short between 5-7, 6-8

Measurement input terminals  
TC·mV(+), RTD(A) terminals  
TC·mV(-), RTD(B) terminals  
RTD(B) terminals

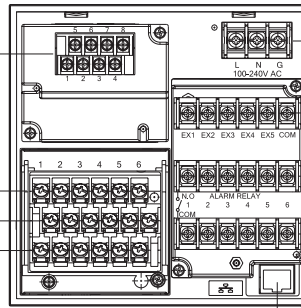

Ethernet connector (option)

### Alarm relay output (4 points 'c' contact) + remote contacts and communication interface

Communication terminal \*RS232C and RS422A/485 are specified on purchase.

	1	2	3	4	5	6	7	8
COM1	RS232C			SG	SD		RD	
	RS422A			SG	SDA	SDB	RDA	RDB
*	RS485			SG	SA	SB	SA	SB
COM2	RS485	SA	SB	SG				

Short between 5-7, 6-8

Measurement input terminals  
TC·mV(+), RTD(A) terminals  
TC·mV(-), RTD(B) terminals  
RTD(B) terminals

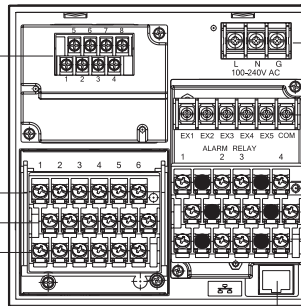

Ethernet connector (option)

## DIMENSIONS

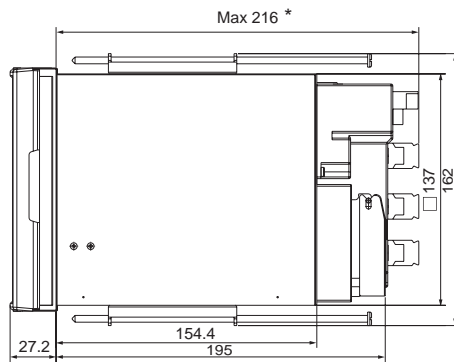
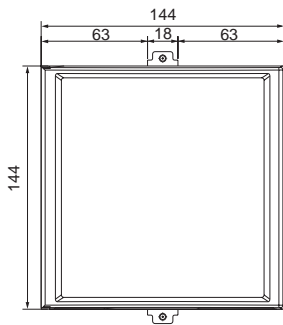

\*Max216, When alarm output/remote contacts unit and communication unit are added

### Panel cutout

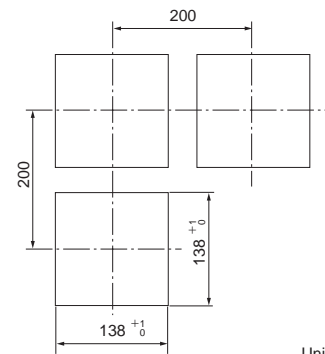

Unit : mm

Specifications subject to change without notice. Printed in Japan (I) 2019. 1

## CHINO CORPORATION

32-8 KUMANO-CHO, ITABASHI-KU, TOKYO 173-8632  
Telephone : +81-3-3956-2171  
Facsimile : +81-3-3956-0915  
E-mail : inter@chino.co.jp  
Website : www.chino.co.jp/