

KP3000 SERIES

DIGITAL PROGRAM SETTER



The KP3000 series is a 96x96mm digital program setter with the analog output accuracy of $\pm 0.1\%$ and maximum 30 program patterns (maximum 19 steps/pattern).

Output signal can be specified from analog output type and digital output type. By combination with a digital indication controller with digital input, the configuration of low cost program control system is enabled.



FEATURES

Program pattern

Settings of maximum 19 steps per pattern and maximum 30 sets of patterns are enabled. Repeating of a whole program pattern, linking of program patterns and repeating of a specific step in a program pattern are enabled, too.

Analog output type and digital output type

Output of setting unit is selected from high accuracy (0.1%FS) analog output type and digital output type which has no setting error by using communications function.

Communications 2-port type provided

Models with 2 communications ports are available. In addition, speeding up and highly-functionalization of communications have been realized. For example, you can use 1 port for high order communications with a personal computer and another port for the communications remote (digital remote) function. The communications protocol can be arbitrarily selected from [MODBUS] and [PRIVATE].

In the digital output type, however, 1-port type of communications is only available.

DI/DO arbitrarily-allocation

When the digital input (DI) or the digital output (DO) is added, arbitrarily-allocation for assigning functions to those DI/DO's is enabled. It is the function enabling allocations such as [External drive input] to DI1 to DI3 and [Pattern selecting input] to DI4 to DI6.

Conforming to international safety standards and European directives (CE)

The controller is conformity with European directives (CE), and is UL and c-UL approved.

Conforming to RoHS

The controller is an environmental consideration product which does not contain directed hazardous substances such as lead, etc.

MODELS

KP3-□0C□□□□□□

Output signal

- 1: Digital output (RS422A)
- 2: Analog output (4 to 20mA)
- 4: Analog output (0 to 10V)
- 5: Analog output (0 to 1V)
- 6: Analog output (Others)
- 7: Digital output (RS485)

1st zone*

- 0: None
- P: 6 Digital inputs
- T: 6 Digital outputs

2nd zone*

- 0: None
- P: 6 Digital inputs*¹
- T: 6 Digital outputs*¹

3rd zone*

- 0: None
- R: Communications 1 port (RS232C) + 3 Digital inputs*²
- A: Communications 1 port (RS422A) + 1 Digital input*³
- S: Communications 1 port (RS485) + 3 Digital input*²
- B: Communications 2 ports (RS232C + RS232C) + 1 Digital input*⁴
- C: Communications 2 ports (RS232C + RS422A) + 1 Digital input*⁴
- D: Communications 2 ports (RS232C + RS485) + 1 Digital input*⁴
- E: Communications 2 ports (RS485 + RS232C) + 1 Digital input*⁴
- F: Communications 2 ports (RS485 + RS422A) + 1 Digital input*⁴
- G: Communications 2 ports (RS485 + RS485) + 1 Digital input*⁴
- P: 6 Digital inputs*⁴
- T: 6 Digital outputs*⁴
- U: 8 Digital inputs*⁴
- W: 8 Digital outputs*⁴
- Y: 3 Digital inputs + 5 Digital outputs*⁴
- Z: 4 Digital inputs + 4 Digital outputs*⁴

Case color

- G: Gray
- B: Black*

Panel sealing and terminal cover*

- 0: None
- 1: Terminal cover
- 2: IP54 panel sealing
- 3: IP54 panel sealing + Terminal cover

Power supply voltage

- A: 100 to 240V (AC)
- D: 24VAC/24VDC

* Option

*¹ It can be selected when the control signal is 1 or 7 only.

*² The digital input is 1 point for the control signal of 1 or 7.

*³ It can be selected when the control signal is 2, 4, 5, 6 or 7 only.

*⁴ It can be selected when the control signal is 2, 4, 5 or 6 only.

Note: For options common to 1st zone, 2nd zone and 3rd zone, assign them in order of [P] and [T] from 3rd zone first

SCREENS

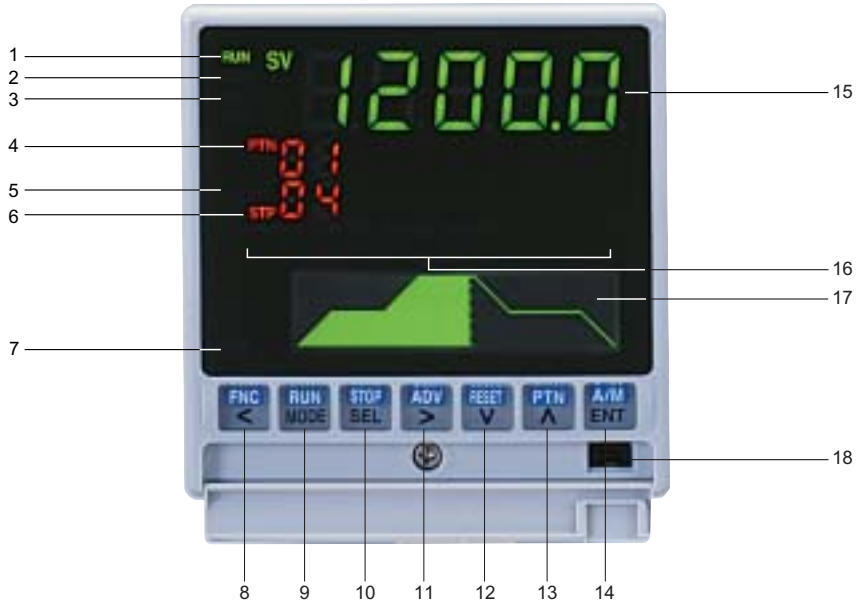

Upper display

- 1. Operation status (RUN) indication
Lights in operation.
- 2. Operation stop (STOP) indication
Lights in the state of operation stop.
- 3. RESET indication
Lights when operation is cancelled and returns to the start point.
- 4. Pattern No. (PTN) indication
- 5. Program remote (REM) indication
Lights when operation is executed by digital input.
- 6. Executing step number (STP) indication
The step No. being executed is indicated.
- 7. Function (FNC) operation indication
Lights when the function key is operated.

Function keys

- 8. FNC key
With the operation screen displayed, pressing it puts the controller in the operation key mode. With the settings screen displayed, pressing it puts the controller in the setting key mode and it operates to move the cursor backwards.
- 9. RUN key
In the operation key mode, it operates as Run key. With the settings screen displayed, pressing it puts the controller in the setting key mode and it is used for switching between the operation screen and the mode screen of Mode 0, or for switching from the settings screen to the mode screen.
- 10. STOP key
In the operation key mode, it operates as Stop key. With the settings screen displayed, pressing it puts the controller in the setting key mode and it is used to switch the settings screen.
- 11. ADV key
In the operation key mode, it operates as Advance key. With the settings screen displayed, pressing it puts the controller in the setting key mode and it is used for moving the cursor and for selecting a parameter.
- 12. RESET key
In the operation key mode, it operates as Reset key. With the settings screen displayed, pressing it puts the controller in the setting key mode and it is used for changing a setting value (or selecting a parameter) in descending order.
- 13. PTN key
In the operation key mode, it operates as Pattern key. With the settings screen displayed, pressing it puts the controller in the setting key mode and it is used for changing a setting value (or selecting a parameter) in ascending order.
- 14. ENT key
It is used for registering the settings.
- 18. Engineering port

Lower display

- 17. A wide variety of operation screens are prepared and arbitrarily-selection is enabled. On the whole program pattern display screen, the simultaneous display of the shape of whole program pattern and the progressed pattern position has been realized.



Time screen



Pattern screen

■ OUTPUT SPECIFICATIONS

Output signal: Analog output 4 to 20mA, 0 to 1V, 0 to 10V
 Digital output RS422A, RS485

Accuracy rating: $\pm 0.1\%$ of full scale

Output updating cycle:
 Analog output Approximately 0.1 seconds
 Digital output Approximately 1 second

Resolution: Approximately 1/30000

Output impedance: Voltage output Approximately 10 Ω

Load resistance: Current output 400 Ω or less
 Voltage output 50k Ω or more

■ DISPLAY SPECIFICATIONS

Upper display: LED
 Lower display: LCD (with back light) 108 x 24 dots

■ GENERAL SPECIFICATIONS

No. of program patterns:
 30 patterns
 Pattern repetition ... Max.9999 times

No. of program step:
 19 step/pattern
 Step repetition ... Max.99 times

Rated power voltage:
 General power supply specifications 100 to 240VAC
 24V Power supply specifications 24VAC/24VDC

Rated power supply frequency:
 General power supply specifications 50/60Hz
 24V Power supply specification 50/60Hz (24VAC)

Maximum power consumption:
 General power supply specifications
 Without options 100VAC 10VA
 240VAC 15VA
 With options 100VAC 15VA
 240VAC 20VA
 24V Power supply specifications
 Without options 24VAC 10VA
 24VDC 5W
 With options 24VAC 15VA
 24VDC 10W

Power failure countermeasures:
 Settings stored in EEPROM (Rewrite count: One million times or less) and stored by a lithium battery for 5 years or more

Terminal screws: M3.5

Insulation resistance:
 Between primary terminals and secondary terminals
 20M Ω or more (500VDC)
 Between primary terminals and protective conductor terminal
 20M Ω or more (500VDC)
 Between secondary terminals and protective conductor terminal
 20M Ω or more (500VDC)

Withstand voltage: Between primary terminals and secondary terminals
 1500VAC (For 1 minute)
 Between primary terminals and protective conductor terminal
 1500VAC (For 1 minute)
 Between secondary terminals and protective conductor terminal
 500VAC (For 1 minute)
 *Primary terminal: Terminals for power supply (100 to 240VAC)

Casing: Fire-retardant polycarbonate
 Color: Gray or black
 Mounting: Panel mounting

External dimensions:
 96 (H) x 96 (W) x 127 (D) mm
 *The depth from the front panel is 120mm.

Weight: Without options Approximately 450g
 With options Approximately 580g

■ SAFTY STANDARD

CE directives: EN61326: 1997 +A1+A2+A3
 EN61010-1: 2001 (Overvoltage category II, pollution degree 2)

* Under the test conditions of EMC directives, there may be variation of indication value or output value which is equivalent to maximum $\pm 10\%$ or maximum 2mV, whichever is greater.

UL: UL61010-1 2nd edition
 c-UL: CAN/CSA C22.2 No.61010-1-04

■ REFERENCE OPERATION CONDITIONS

Ambient temperature:
 23°C \pm 2°C

Ambient humidity: 55%RH \pm 5% (No condensation)

Power voltage: General power supply specifications
 100VAC \pm 1%
 24V power supply specifications
 24VDC \pm 1%

Power supply frequency:
 General power supply specifications
 50/60Hz \pm 0.5%
 24V power supply specifications
 DC

Mounting angle: Forward or backward $\pm 3^\circ$, lateral $\pm 3^\circ$

Installation height: Altitude 2000m or below

Vibration: 0m/s²

Impact: 0m/s²

Mounting condition:
 Single-unit panel mounting (Space above, below, right and left of unit is needed.)

Wind: None

External noise: None

Warm up time: 30 minutes or longer

■ NORMAL OPERATION CONDITIONS

Ambient temperature:
 -10°C to 50°C (-10°C to 40°C for closed installation)

Ambient humidity: 10 to 90%RH (no condensation)

Power voltage: General power supply specifications 90 to 264VAC
 24V Power supply specifications 21.6 to 26.4VDC/AC

Power supply frequency:
 General power supply specifications 50/60Hz \pm 2%
 24V Power supply specifications DC, 50/60Hz \pm 2%

Mounting angle: Forward or backward $\pm 10^\circ$, lateral $\pm 10^\circ$

Installation height: Altitude 2000m or below

Vibration: 2m/s²

Shock: 0m/s²

Mounting condition:
 Single-unit panel mounting (Space above and below of the unit is needed.)

External noise: None

Rate of ambient temperature change:
 10°C/hour or less

■ TRANSPORT CONDITIONS

Ambient temperature:
 -20°C to 60°C

Ambient humidity: 5 to 90%RH (no condensation)

Vibration: 4.9m/s² (10 to 60Hz)

Impact: 392m/s²
 Under the condition that the unit is packed for shipment by the factory

■ STORAGE CONDITIONS

Ambient temperature:
 -20°C to 60°C
 For long term storage, the temperature should be 10°C to 30°C.

Ambient humidity: 5 to 90%RH (no condensation)

Vibration: 0m/s²

Impact: 0m/s²
 Under the condition that the unit is packed for shipment by the factory

■ OPTIONS

● Communications interface

With RS232C, RS422A or RS485, the setting and measured values of the controller can be transmitted to a master CPU and various parameters can be set by the master CPU.

Number of communications points:

2 points

Communications type: RS232C, RS422A, RS485

Communication speed: 2400/4800/9600/19200/38400 bps

Protocol: MODBUS (RTU), MODBUS (ASCII), PRIVATE

● Digital signal input

The following switching is enabled by digital input signal.

Input signal: No-voltage contact, open-collector signal

External contact capacity:

5VDC 2mA

Functions:

1. Selection of pattern No. (6 points)

2. Run/stop

3. Advance

4. Reset

5. Wait

6. Fast

● Digital signal output

Time signal or status signal can be outputted externally open-collector signal.

Output signal: Open-collector signal

Capacity: 24VDC, Maximum 50mA

Functions:

1. Time signal (Maximum 8 points)

2. Run/stop

3. Advance

4. Reset

5. Wait

6. End

● Panel sealing

By mounting the controller to a panel, it has the panel sealing equivalent to [IP54 compliance].

● Terminal cover

It covers the terminals for safe. The cover is transparent.

TERMINAL ARRANGEMENT

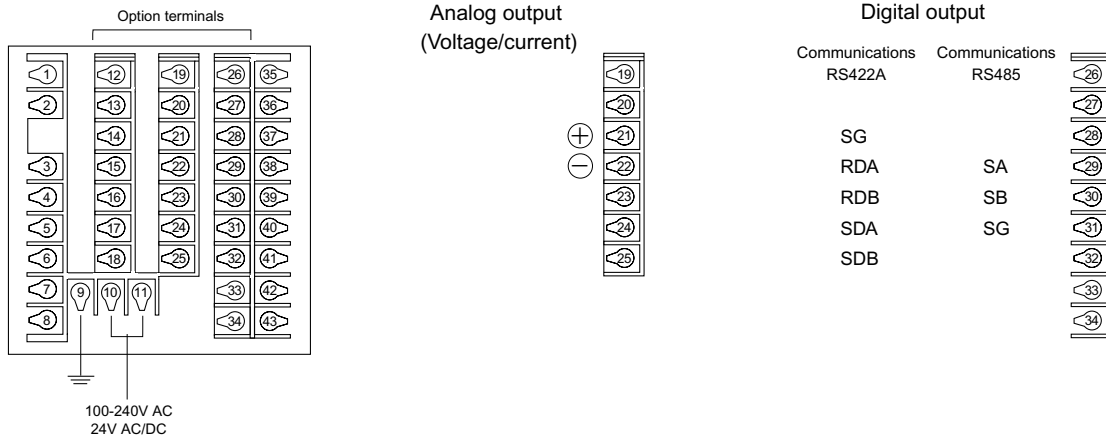

Digital output + Communications

	Communications RS232C + Digital output RS422A + 1 digital input	Communications RS485 + Digital output RS422A + 1 digital input	Communications RS232C + Digital output RS485 + 1 digital input	Communications RS485 + Digital output RS485 + 1 digital input	Digital output RS485 + Communications RS422A + 1 digital input
RD	SA	RD	SA	SA	
SD	SB	SD	SB	SB	
SG	SG	SG	SG	SG	
RDA	RDA	SA	SA	RDA	
RDB	RDB	SB	SB	RDB	
SDA	SDA	SG	SG	SDA	
SDB	SDB			SDB	
DI	DI	DI	DI	DI	
COM	COM	COM	COM	COM	

Option terminals

Options common to each zone

P

T

1st ← 2nd ← 3rd zone

DI
DI
DI
DI
DI
DI
COM

DO
DO
DO
DO
DO
DO
COM

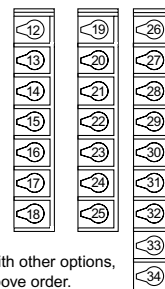

P: 6 digital inputs
T: 6 digital output

Based on combination with other options, assign the zone in the above order.

3rd zone

Terminals	R	A	S	B	C	D	E	F	G	U	W	Y	Z
26	RD	RDA	SA	RD1	RD1	RD1	SA1	SA1	SA1	DI	DO	DO	DO
27	SD	SDB	SB	SD1	SD1	SD1	SB1	SB1	SB1	DI	DO	DO	DO
28	SG	SDA	SG	SG1	SG1	SG1	SG1	SG1	SG1	DI	DO	DO	DO
29	DI	SDB	DI	RD2	RDA2	SA2	RD2	RDA2	SA2	DI	DO	DO	DO
30	DI	SG	DI	SD2	RDB2	SB2	SD2	RDB2	SB2	DI	DO	DO	DI
31	DI	DI	DI	SG2	SDA2	SG2	SG2	SDA2	SG2	DI	DO	DI	DI
32	COM	COM	COM		SDB2			SDB2		DI	DO	DI	DI
33				DI	DI	DI	DI	DI	DI	DI	DO	DI	DI
34				COM	COM	COM	COM	COM	COM	COM	COM	COM	COM

R: Communications RS232C + 3 Digital inputs

A: Communications RS422A + 1 Digital input

S: Communications RS485 + 3 Digital inputs

B: Communications RS232C + Communications RS232C + 1 Digital input

C: Communications RS232C + Communications RS422A + 1 Digital input

D: Communications RS232C + Communications RS485 + 1 Digital input

E: Communications RS485 + Communications RS232C + 1 Digital input

F: Communications RS485 + Communications RS422A + 1 Digital input

G: Communications RS485 + Communications RS485 + 1 Digital input

U: 8 Digital inputs

W: 8 Digital outputs

Y: 3 Digital inputs + 5 Digital outputs

Z: 4 Digital inputs + 4 Digital outputs

● ABOUT CRIMP STYLE TERMINALS

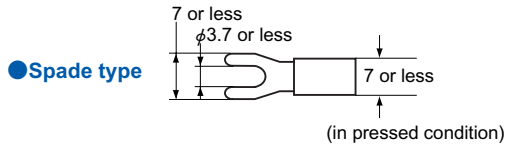
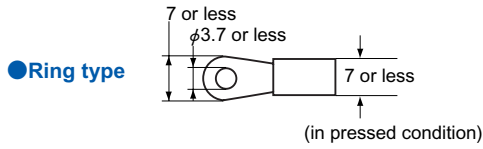

*Use terminal with insulation

■ EXTERNAL DIMENSIONS

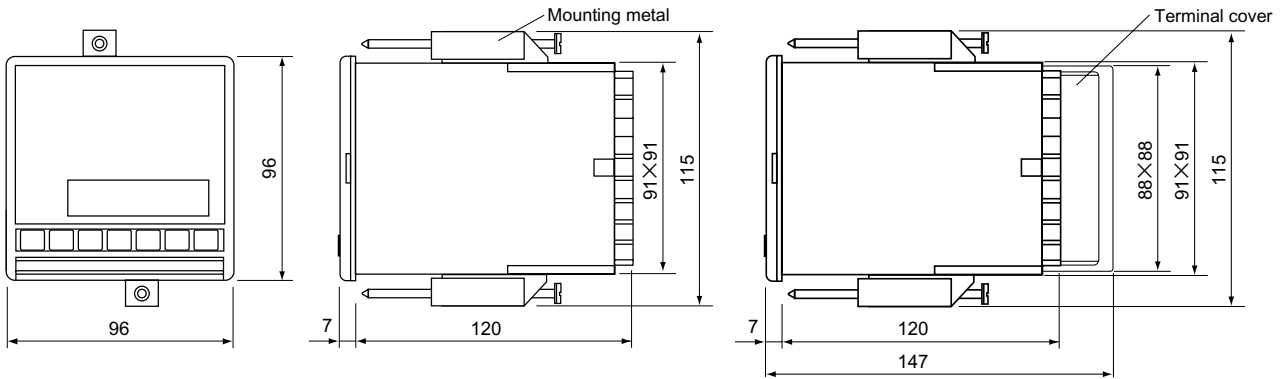

● PANEL CUTOUT

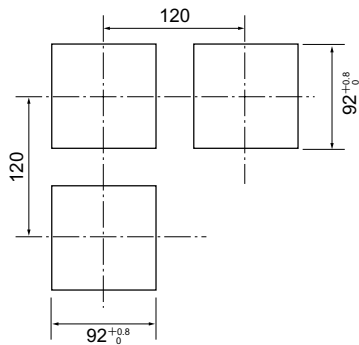

● Closed mounting panel dimensions

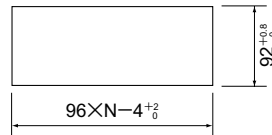

N: Number of mounted instruments

Unit: mm

Specifications subject to change without notice. Printed in Japan (I) 2018. 8

CHINO CORPORATION

32-8 KUMANO-CHO, ITABASHI-KU, TOKYO 173-8632
 Telephone : +81-3-3956-2171
 Facsimile : +81-3-3956-0915
 E-mail : inter@chino.co.jp
 Website : www.chino.co.jp/