

KR3000 SERIES GRAPHIC RECORDER



KR3000 series are network-compatible paperless recorders with high performance and high operating function employed high visibility 12.1" TFT color LCD display and touch panel operation system. High speed of sampling rate 100ms for all points and high accuracy of $\pm 0.1\%$ were realized, and measured data is stored into internal memory and maximum 8GB compact flash card (CF card).

As it can be monitored by a web browser display on several computers on intranet or internet, FTP transfer of data file and E-mail notification are also available.



FEATURES

- Large sized 12.1" TFT color LCD display**
 - Large-sized high visibility display with various display functions. Real time/historical trend screen, bar-graph screen, data screen are selectable for various applications.
 - Combination display for selected 4 screens is available. It is easy to switch to individual screen by touching panel.
- Large capacity of data memory and various recording method**
 - Compact flash card (CF card) slot is equipped as standard external memory. Large capacity storage of maximum 8GB is available.
 - Various data storing methods are selectable such as schedule programming by time of day and time of date, recording start-up by external signal and event, and data logging of before and after trigger points for alarm.
- Multi points recording with high speed/high accuracy**
 - High-speed recording of approximately 100ms for all points and high accuracy of $\pm 0.1\%$ were realized. Stable measuring and recording are possible with high speed.
 - High withstand voltage of 1000V AC between input channels. (Except resistance thermometer input)
- Easy operating and programming without manuals**
 - Easy operating by dedicated keys for each function and touch panel.
 - Various functions such as scrolling of real time trend and historical trend by panel touching are available.
 - USB port is prepared in front compartment. Setting file and data file are stored in USB memory stick.
- Writing comments on screen**
 - Comments can be written on screen by a stylus pen.
- Setup and display of CHINO controllers**
 - Parameter setting and recording/displaying of setting/measuring value by connecting maximum 16 units of CHINO controllers to low-order communications (option)
- LAN network capability**
 - Various networked environment such as remote monitoring by browser, FTP server, FTP client and E-mail notification are applied as Ethernet is equipped as standard.
- Analyzing/data acquisition application software (option)**
 - It is easy to replay and edit the recorded data file. Replay display has various mode of vertical/horizontal trend, circular trend, and also has wave-analyzing and marking by using the cursor.
- Custom graphic screen for per each applications (NEW)**
 - By using optional custom graphic screen function, it can display the graphic screen which the user created by PC software KR Screen Designer (optional). Create letters, rectangle, oval, line, etc by drawing tool and allocate KR measuring data while making the background by JPEG or other images. By lower communication, controller SV, MV, PID can also be changed. Register up to 5 screens and its screens are switchable.

MODELS

KR31 -

Measuring points/sampling rate

- 20: 12 points/100ms
- 40: 24 points/100ms
- 60: 36 points/100ms
- 80: 48 points/100ms
- 21: 12 points/1s
- 41: 24 points/1s
- 61: 36 points/1s
- 81: 48 points/1s

Communications interface (option)

- N : None
- R : High order (RS232C)
- S : High/Low order (RS422A/RS485)

Carrying handle and feet (option)

- A : None
- T : With carrying handle and feet *

Digital input/ alarm output (option)

- 0: None
- 1: Alarm output 12 points (a contact)
- 2: Alarm output 6 points (c contact)
- 3: Alarm output 24 points (a contact)
- 4: Alarm output 12 points (c contact)
- 5: Alarm output 12 points (a contact) + 6 points (c contact)
- A: Digital input 8 points
- B: Digital input 8 points + alarm output 12 points (a contact)
- C: Digital input 8 points + alarm output 6 points (c contact)
- D: Digital input 8 points + alarm output 24 points (a contact)
- E: Digital input 8 points + alarm output 12 points (c contact)
- F: Digital input 8 points + alarm output 12 points (a contact) + alarm output 6 points (c contact)

Others (option)

- (Blank) : None
- 1NN : Custom graphic screen

* Non-Conformance to CE

KR3000 SERIES

SCREENS

● Real-time trend screen

Displays data (measured and virtual) of selected group.
Vertical trend and horizontal trend selectable.

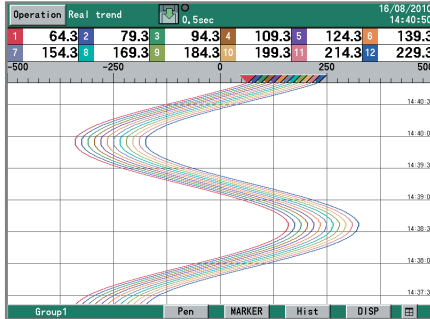

● Bar-graph screen

Displays data (measured and virtual) of selected group.
Combination display with real-time trend is available.

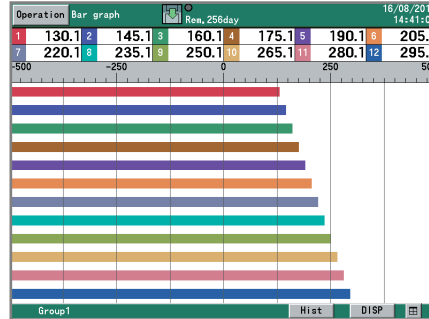

● Data screen

Displays data (measured and virtual) of selected group.
Simultaneous display of alarm status.

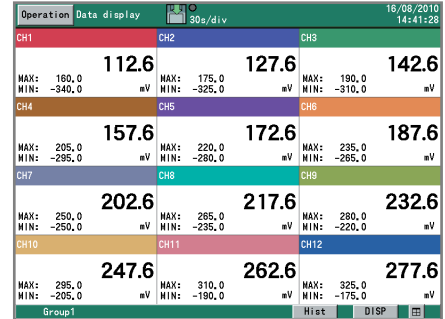

● 4 separate screen

Switchable from displayed 4 screens to individual screen by touch panel.

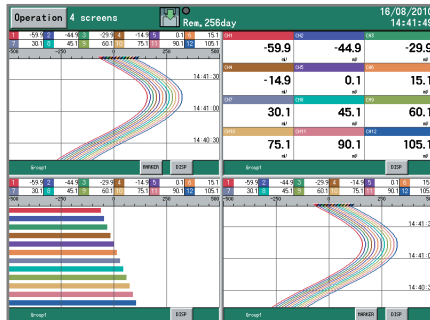

● Circular trend screen

High-resolution color and easy to read outer curve.

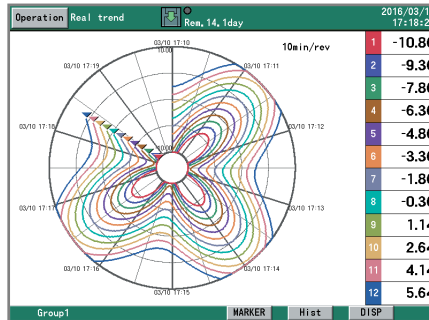

● Graphic screen

Enable to create custom display for each user*.

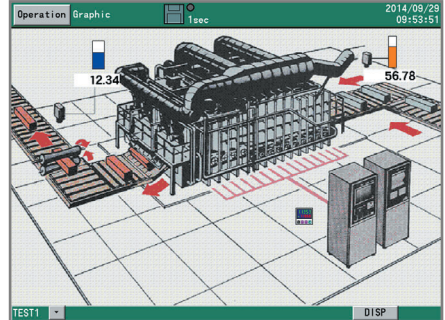

*Graphic screen feature is provided optionally.
BMP image has to be prepared by customer.

Stylus pen writing

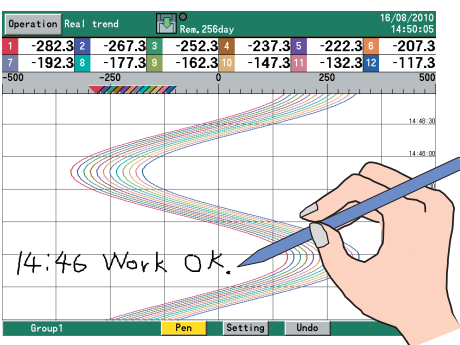

Connectivity

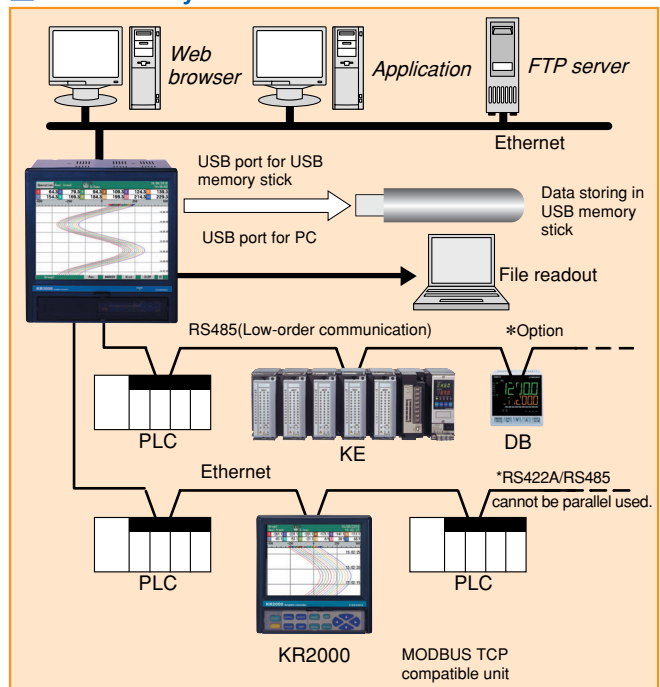

INPUT SPECIFICATIONS

Measuring points: 12 points, 24 points, 36 points and 48 points
 Input types: Universal
 DC voltage --- $\pm 13.8\text{mV}$, $\pm 27.6\text{mV}$, $\pm 69.0\text{mV}$
 $\pm 200\text{mV}$, $\pm 500\text{mV}$, $\pm 2\text{V}$
 $\pm 5\text{V}^*$, $\pm 10\text{V}^*$, $\pm 20\text{V}^*$, $\pm 50\text{V}^*$
 (*with built-in voltage divider)
 DC current --- With external shunt resistor (sold separately)
 Thermocouple --- B, R, S, K, E, J, T, N, PtRh40-PtRh20,
 W-WRe26, WRe5-WRe26, Platinelll, NiMo-Ni,
 CR-AuFe, U, L
 Resistance thermometer --- Pt100, JPt100, Pt50, Pt-Co
 Accuracy ratings: Refer to the table of measuring range and accuracy ratings
 Reference junction compensation accuracy:
 K, E, J, T, N, Platinelll --- $\pm 0.5^\circ\text{C}$ or less
 R, S, W-WRe26, WRe5-WRe26, NiMo-Ni, CR-AuFe,
 U, L --- $\pm 1.0^\circ\text{C}$ or less
 Sampling rate: 100ms --- Approximately 100ms for all points
 1s --- Approximately 300ms for all points
 Burnout: Disconnection of input signal is detected on thermocouple and
 resistance thermometer input. UP/DOWN/DISABLE is selectable
 for each input
 Scaling: Range/scale is selectable when DC voltage/current is
 programmed
 Digital filter: FIR filter
 Allowable signal source resistance:
 Thermocouple input (burnout disable/
 DC voltage input ($\pm 2\text{V}$ or less) --- $1\text{k}\Omega$ or less
 DC voltage input ($\pm 5\text{V}$ or more) --- 100Ω or less
 Resistance thermometer --- Per wire 10Ω or less
 (same resistance for 3 wires)
 Input resistance: DC voltage, thermocouple input --- Approximately $1\text{M}\Omega$
 Maximum input voltage:
 Thermocouple input (burnout disable/
 DC voltage input ($\pm 2\text{V}$ or less) --- $\pm 10\text{VDC}$
 DC voltage input ($\pm 5\text{V}$ to $\pm 50\text{V}$) --- $\pm 60\text{VDC}$
 Thermocouple input (with burnout/
 Resistance thermometer input --- $\pm 6\text{VDC}$
 Maximum common mode voltage:
 30V AC
 Dielectric strength between channels:
 1000V AC or more between each channel
 (High strength semiconductor relay used)
 (B terminal of resistance thermometer is shorted inside between
 channels.)
 Common mode rejection ratio:
 120dB or more (50 or 60Hz)
 Series mode rejection ratio:
 50dB or more (50 or 60Hz)

RECORDING SPECIFICATIONS

Memory for history: 136MB
 Additional memory: CF card (Up to 8GB)
 128MB standard attached, Apacer Technology made
 recommended
 USB memory stick (Up to 8GB)
 Not all USB memory stick allowable
 Recording cycle: 100, 200, 500ms
 1, 2, 3, 5, 10, 15, 20, 30s
 1, 2, 3, 5, 10, 15, 20, 30, 60min
 Logging data: Measured data --- File name (group name), time of day, month
 and year of recording start, tag, measured data, alarm
 status/types and marker text
 Setting parameter
 Storing types: Binary/CSV type
 Storing methods: Manual start/stop (dedicated key and panel touching operation)
 Schedule (designation for time of day and date)
 Trigger signal (alarm event, digital input)
 Data logging of before and after trigger points
 * Pre-trigger is selectable
 Measuring numbers of pre-trigger --- Max 950 data
 Recording group: 6 groups of 56 points/group can be programmed
 (Up to Total of 128 points)

When 12 channels recorded in sampling mode (real data).

Recording cycle	128MB	256MB	512MB	1GB	2GB
0.1 sec	3.16 days	6.32 days	12.6 days	25.3 days	50.6 days
1sec	31.6 days	63.2 days	126 days	253 days	1.4 yrs
60 sec	5.2 yrs	10 yrs	21 yrs	42 yrs	83 yrs

When 24 channels recorded in sampling mode (real data).

Recording cycle	128MB	256MB	512MB	1GB	2GB
0.1 sec	1.58 days	3.16 days	6.32 days	12.6 days	25.3 days
1sec	15.8 days	31.6 days	63.2 days	126 days	253 yrs
60 sec	2.6 yrs	5.2 yrs	10 yrs	21 yrs	42 yrs

When 36 channels recorded in sampling mode (real data).

Recording cycle	128MB	256MB	512MB	1GB	2GB
0.1 sec	1.05 days	2.11 days	4.20 days	8.43 days	16.9 days
1sec	10.5 days	21.1 days	42.0 days	84.3 days	168 days
60 sec	1.7 yrs	3.3 yrs	7 yrs	14 yrs	27 yrs

When 48 channels recorded in sampling mode (real data).

Recording cycle	128MB	256MB	512MB	1GB	2GB
0.1 sec	18.9 days	1.58 days	3.16 days	6.32 days	12.6 days
1sec	7.9 days	15.8 days	31.6 days	63.2 days	126 yrs
60 sec	1.3 yrs	2.6 yrs	5.2 yrs	10 yrs	21 yrs

COMPUTATION SPECIFICATIONS

Computation points: Maximum 128 points
 Computation cycle: 100ms for all points
 Computation types: Arithmetic operations --- Addition, subtraction, multiplication,
 division, remainder, exponential
 Comparison operations --- Equality, inequality, great, less,
 equality/great, equality/less
 Logical operations --- AND, OR, XOR, NOT

General functions --- Round-up, round-down, absolute
 value, square root, exponent of e,
 natural logarithm, common logarithm
 Integration operations --- Analog integration, digital integration
 Channel data operations --- Measured data computation,
 calculated data computation
 moving average, previous data, first
 order lag filter
 Others --- Dew point, relative humidity, F-value
 wind direction, 16 direction display,
 increment per time (increment per set
 unit time),
 remaining amount of CFcard,
 linearization table, data
 communications input

ALARM SPECIFICATIONS

Setups: Up to 4 alarms can be programmed per channel
 Alarm types: Upper limit, lower limit, differential upper limit, differential lower
 limit (deadband is selectable), abnormal data
 Delay function: Setup range of alarm delay --- 1 to 3600 seconds
 Alarm settings: AND/OR selectable
 Alarm outputs: Refer to option specification

DISPLAY SPECIFICATIONS

Display: 12.1" TFT color LCD
 Display types: Measured data display
 (Trend screen, Data screen, Bar-graph screen)
 Historical trend display
 (simultaneous display with Real-time trend is available)
 Information display
 (alarm display, marker list, file list)
 Setting screen
 (alarm, computation, memory, system, maintenance,
 communication, etc.)
 Trend screen: 48 colors selectable
 Display screen --- 6 screens (6 groups)
 Display points --- Maximum 56 points/screen
 Time axis direction --- Vertical or horizontal
 Line width --- 1 to 5 dot selectable
 Scale display --- 4 scales
 Tag/data display --- Show/hide selectable
 Marker display
 Data screen: Display screen --- 6 screens (6 groups)
 Display points --- Maximum 56 points/screen
 Display contents --- Measured value, channel/tag, unit, alarm
 status
 Bargraph screen: 48 colors selectable
 Display screen --- 6 screens (6 groups)
 Display points --- Maximum 56 points/screen
 Display direction --- Vertical or horizontal
 Scale display --- 1 scale
 Information display: Alarm display (alarm activation/released history display)
 Marker list
 File list (group data file list display)
 Unit information (Model, serial no., option, etc.)
 LCD back light: Auto/manual OFF function
 Brightness --- 4 levels adjustment
 *The LCD display may contain some pixels that always or never illuminate, and the brightness of
 some areas of the display may appear uneven. There are typical LCD performance characteristics
 and do not constitute malfunctions.

DIRECT WRITING SPECIFICATION

Storage: Storing in recording file of internal/external memory
 External memory file available when recording data is stored as
 binary type
 Line width: 10 phases
 Color: 16 colors
 Drawing screen: Real time trend, historical trend
 Maximum drawing points:
 $8000\text{ points/file}^*$
 *Trajectory point

COMMUNICATION FUNCTIONS

Network

Communication type: Ethernet (10BASE-T/100BASE-TX)
 FTP server: Data file can be read from the network computer
 FTP client: Transfer a data file to a network server
 SNMP client: The time can be synchronized to the time of SNMP server
 Web server: Conformed to HTTP1.0 --- Display the alarm, information of
 maintenance by browser software (InternetExplorer5.0 or later,
 NetScape6.0 or later, Opera7 or later)
 * User's ID and password registration available
 E-Mail: E-Mail notification at specified time for alarm activation
 Report data at specified time is selectable from all registered
 data
 Corresponds to SSL and TLS.
 Notification address --- Maximum 8 contacts
 MODBUS TCP: Read and write the data of compatibles units.

USB Communications

Communication type: USB2.0 (full speed), host function
 USB memory stick is used as external memory
 Some USB memory stick cannot be used.

KR3000 SERIES

PROGRAMMING/OPERATION

Operation method: Touch panel/dedicated key
 Operation keys: HOME, MENU, DISP, MARKER, SCROLL, CURSOR, START, STOP, DIRECTION keys, ENTER, ESC
 HOME settings: Simple recording settings --- Common setting to all channels
 Parameter programming for all channels together, recording cycle, selection settings
 MENU settings: Input/computation programming --- Input parameter, computation parameter
 DISP Settings --- Data channel parameter, group parameter, common parameter (combination display, trend vertical/horizontal)
 Alarm settings
 File settings (6 individual files) --- Storing method settings
 Marker text settings
 System settings --- Communication, clock, maintenance, key lock, password, screen, etc.
 DISP operations: Operating screen selection --- Trend, data, bar-graph, historical trend, alarm display, maker list
 Display selection on each screen --- Group 1 to 6 selectable

GENERAL SPECIFICATIONS

Rated power voltage: 100 to 240V AC (universal power supply) 50/60Hz
 Maximum power consumption: 65VA
 Reference operating condition:
 Ambient temperature --- 21 to 25°C,
 Ambient humidity --- 45 to 65%RH
 Power voltage --- 100V AC±1.0%
 Power frequency --- 50/60Hz±0.5%
 Attitude --- Left/right 0°, forward/backward 0°
 Warm-up time --- Longer than 30 minutes
 Normal operating condition:
 Ambient temperature --- 0 to 50°C
 Ambient humidity --- 20 to 80%RH
 Power voltage --- 90 to 264V AC
 Power frequency --- 50/60Hz±2%
 Attitude --- left/right 0°, forward tilting 0°, backward tilting 0° to 20°
 Transport condition (at the packed condition on shipment from our factory):
 Ambient temperature --- -20 to 60°C
 Ambient humidity --- 5 to 90%RH (No dew condensation)
 Vibration --- 10 to 60Hz 4.9m/ S² (0.5G) or less
 Impact --- 392m/S² (40G) or less
 Storage condition:
 Ambient temperature --- -20 to 60°C
 Ambient humidity --- 5 to 90%RH (No dew condensation)
 Power failure protection:
 Setups and data are backed up by flash memory.
 Clock: Lithium battery backs up RAM (Minimum 5 years)
 Insulation resistance: Secondary terminals and protective conductor terminals --- 20MΩ or more at 500V DC
 Primary terminals and protective conductor terminals --- 20MΩ or more at 500V DC
 Primary and secondary terminals --- 20MΩ or more at 500V DC
 Primary terminals: power terminals (L,N), alarm output terminals
 Secondary terminals: measuring input terminals, digital input terminals, communications terminals
 Dielectric strength: Secondary terminals and protective conductor terminals --- 1 minute at 500V AC
 Primary terminals and protective conductor terminals --- 1 minute at 1500V AC
 Primary and secondary terminals --- 1 minute at 2300V AC
 Primary terminals: power terminals (L,N), alarm output terminals
 Secondary terminals: measuring input terminals, digital input terminals, communications terminals
 Case assembly material:
 Front bezel --- ABS resin
 Case --- Steel
 Color: Front bezel --- Black (equivalent to Munsell N3.0)
 Case --- Painting color, gray (equivalent to Munsell N7.0)
 Weight: 7.2kg
 Mounting: Panel mounting
 Terminal screws: Power terminals/protective conductor terminals/communications terminals --- M4.0
 Measuring input terminals/alarm output terminals/digital input terminals --- M3.5

OPERATION KEYS

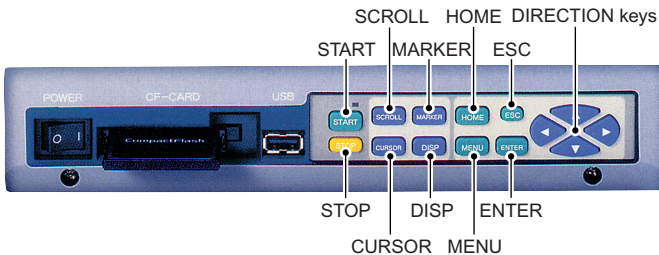

STANDARDS

CE: EMC directive --- EN61326-1 Class A
 EN61000-3-2
 EN61000-3-3
 Low voltage directive --- EN61010-1
 Over voltage (installation) category II, pollution level 2, measuring category II
 Protection: Conformed to IEC60529 IP54 (recorder front bezel)

OPTION

Options	Specifications
Alarm output	Mechanical relay contact output for abnormal input and alarm activation Output: 24 points (a contact), 12 points (a contact, c contact), 6 points (c contact) Contact rating: Mechanical relay --- 100V AC 0.5A, 240V AC 0.2A, 30V DC 0.3A
Communications interface	High-order communications (RS232C) Communications interface for high-order units Use for data acquisition, parameter setting and operation by a unit or PC connected to high-order RS232C (MODBUS) *Ethernet is standard equipped
	High-order /low-order communications (RS422A/RS485) Communications interface for high-order and low-order units RS422A/RS485 (MODBUS) switchable Choose one from the following 2 types ● Communications interface for high-order units Use for data acquisition, parameter setting and operation by a unit or PC connected to high-order ● Recording of input data of CHINO products connected to low-order Parameter setting and recording/displaying of setting/measuring value of maximum 16 units of CHINO controllers Recording points: 12 points --- 108 points 24 points --- 96 points 36 points --- 84 points 48 points --- 72 points Measuring cycle: 1s/unit Connecting models: KE, SE3000 KR2000, KR3000 LE5000, AL3000, AH3000, AL4000, AH4000, DB1000, 2000, LT230, 830 350, 370, 450, 470 DP-G (data acquisition only) JU, JW Controller setting parameter: RUN/READY Execution No. (1↔2 only) AUTO/MANUAL REMOTE/LOCAL SV, MV, alarm setting value 1-4, PID Controller acquisition parameter: PV, SV, MV1-2 Execution SV, execution EV1-4 Execution PID, execution No. Event status * Transfer input data of KR3000 to PLC. The input data can be written on PLC only. Data writing points: 44 points Connectable PLC: Mitsubishi Electric Corporation MELSEC AnA, QnA, QnAS, FX series OMRON Corporation SYSMAC series Note) Separate purchase of protocol converter SC8-10 (optional) is required for connection to OMRON PLC.
Digital inputs	ON/OFF signal ON/OFF input recording
	Pulse input Maximum 10Hz pulse input Used for flow, operating time and frequency Input system: Photocoupler isolation (Common use for contact and pulse input) Built-in isolated power supply (approx. 5V) Input type: Non-power contact, open collector (TTL or transistor)
	Remote contact The following operations are available by contact input 8 points and common signal 4 points (Selectable by parameter). * Data memory triggering Start data recording by conductive signal from OFF to ON Data recording while conductive signal is ON * Marker display Registered makers display by conductive signal from OFF to ON * Integration operations Reset data for integration operations (all channels simultaneously)
Custom Graphic Screen	By KR Screen Designer (optional), create graphic screen by PC and display to KR screen via CF card. KR measuring value can be located to the screen.
Others	Handle and feet, point indication card

KR SCREEN DESIGNER (sold separately) (NEW)

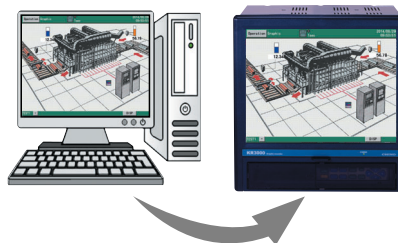

Model: KS3200-000
 OS: Windows Vista/7/8
 Others: Your OS recommended requirements or better

MEASURING RANGES/ACCURACY RATINGS

Input type	Measuring range	Accuracy ratings
DC voltage	-13.80 to 13.80mV -27.60 to 27.60mV -69.00 to 69.00mV -200.0 to 200.0mV -500.0 to 500.0mV -2.000 to 2.000V	±0.1%±1digit
	(with built-in voltage divider) -5.000 to 5.000V -10.00 to 10.00V -20.00 to 20.00V -50.00 to 50.00V	
T/C	K -200.0 to 300.0°C -200.0 to 600.0°C -200 to 1370°C	±0.1%±1digit * -200 to 0°C: ±0.2%±1digit
	E -200.0 to 200.0°C -200.0 to 350.0°C -200 to 900°C	
	J -200.0 to 250.0°C -200.0 to 500.0°C -200 to 1200°C	
	T -200.0 to 250.0°C -200.0 to 400.0°C	±0.1%±1digit * 0 to 400°C: ±0.2%±1digit
	R 0 to 1200°C 0 to 1760°C	
	S 0 to 1300°C 0 to 1760°C	±0.1%±1digit * 0 to 400°C: Out of accuracy ratings * 400 to 800°C: 0.15%±1digit
	B 0 to 1820°C	
	N -200.0 to 400.0°C -200.0 to 750.0°C -200 to 1300°C	±0.15%±1digit * -200 to 0°C: ±0.3%±1digit
	W-WRe26 0 to 2315°C	
	WRe5-WRe26 0 to 2315°C	±0.2%±1digit
	PtRh40-PtRh20 0 to 1888°C	±0.2%±1digit * 0 to 300°C: ±1.5%±1digit * 300 to 800°C: ±0.8%±1digit
	NiMo-Ni -50.0 to 290.0°C -50.0 to 600.0°C -50 to 1310°C	±0.2%±1digit
	CR-AuFe 0.0 to 280.0K	±0.2%±1digit * 0 to 20K: ±0.5%±1digit * 20 to 50K: ±0.3%±1digit
	PlatineII 0.0 to 350.0°C 0.0 to 650.0°C 0 to 1395°C	±0.15%±1digit
	U -200.0 to 250.0°C -200.0 to 500.0°C -200.0 to 600.0°C	±0.15%±1digit * -200 to 0°C: ±0.3%±1digit
L -200.0 to 250.0°C -200.0 to 500.0°C -200 to 900°C	±0.1%±1digit * -200 to 0°C: ±0.2%±1digit	
RTD	Pt100 -140.0 to 150.0°C -200.0 to 300.0°C -200.0 to 850.0°C	±0.1%±1digit * -140.0 to 150.0°C 700 to 850°C: ±0.15%±1digit
	JPt100 -140.0 to 150.0°C -200.0 to 300.0°C -200.0 to 649.0°C	±0.1%±1digit * -140.0 to 150.0°C: ±0.15%±1digit
	Pt50 -200.0 to 649.0°C	±0.1%±1digit
	Pt-Co 4.0 to 374.0K	±0.15%±1digit * 4 to 50K: ±0.3%±1digit

Note: The accuracy ratings are converted into the measuring range under reference operating condition. Thermocouple input does not contain reference junction compensation accuracy.
 K,E,J,T,R,S,B,N:IEC584,JIS C1602-1995
 W-WRe26,WRe5-WRe26,PtRh40-PtRh20,PlatineII,NiMo-Ni,
 Cr-AuFe:ASTM Vol14.03
 U(Cu-CuNi),L(Fe-CuNi):DIN43710
 Pt100:IEC751(1995),JIS C1604-1997
 JPt100:JIS C1606-1989

APPLICATION SOFTWARE ZAILA (sold separately)

The software is applied for replay display/wave editing operation of recorded data in KR3000 series. It has replay display of vertical/horizontal trend and circular trend function, and also analyzing function such as magnify/reduce/partially magnify of graphs and message insert.

Display examples

Trend display window (vertical flow)

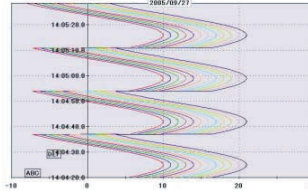

Trend display window (horizontal flow)

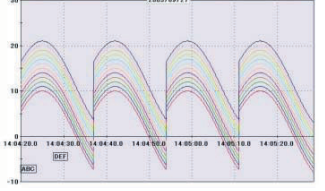

Trend display window (circular trend)

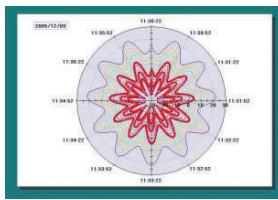

Bar-graph

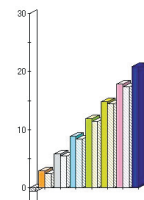

Main functions

Trend display

Selectable from trend display window (vertical flow, horizontal flow) and circular trend display window.

Continuous replay display window

Trend is scrolled continuously (automatically).
 Scroll changes by speed and renewal data no.

Data list display window

Displays registered data as list display.

Bar-graph

Displays by bar. Message can be inserted into bar-graph.

Data between markers

Displays date/time, time difference between 2 data, data difference, maximum, minimum, average, standard deviation and median among all data.

Alarm display

Points for alarm activation at each level are displayed on a trend graph.

Settings

Cursor, trend line, scale axis, time axis, title input on the graph, graph assistant and magnify/reduce/rotation of graphs

Data conversion

Exporting to Excel, and converting to CSV file or TEXT file are available.

ENVIRONMENT

CPU	Your OS recommended CPU and/or upper grade
OS	Windows VISTA / 7 / 8 *Internet Explorer 6.0 or later
Others	Your OS recommended memory or larger
Disk drive	CD-ROM drive: 1 drive or more Hard disk drive: Disk space of 1 drive or more for 100MB or more
Language	Japanese, English, Chinese (simplified and traditional characters), Korean

■ TERMINAL ARRANGEMENT

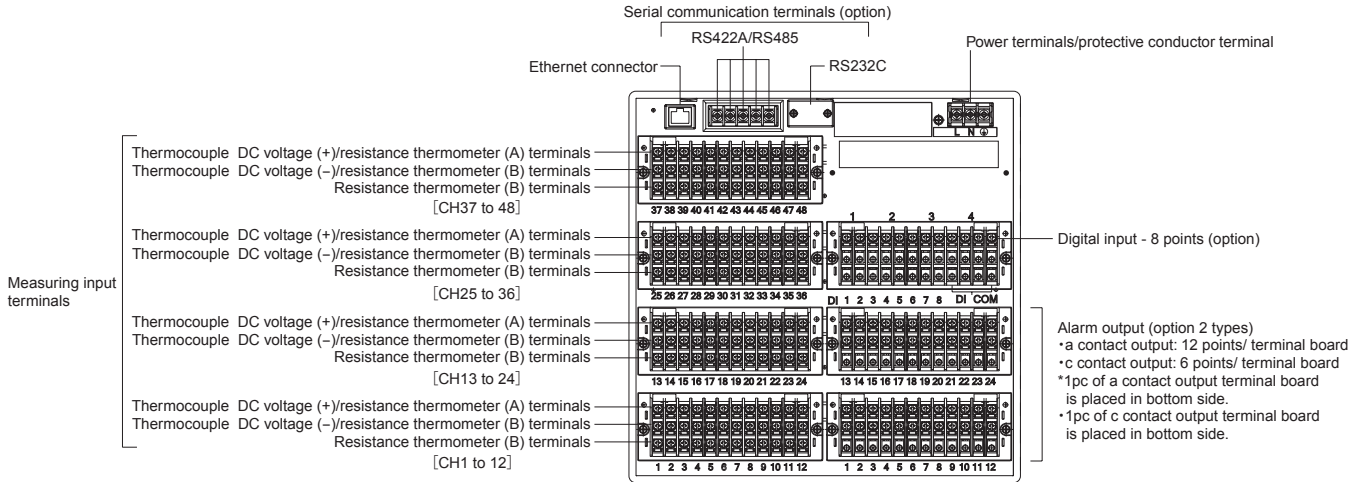

● Alarm/Digital input terminals

● Alarm output (a contact output 12 points)

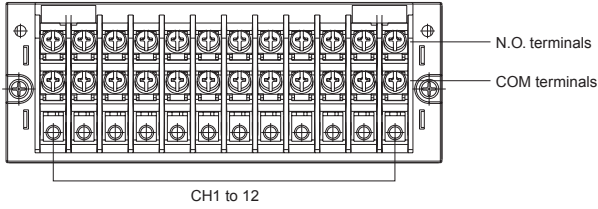

● Alarm output (c contact output 6 points)

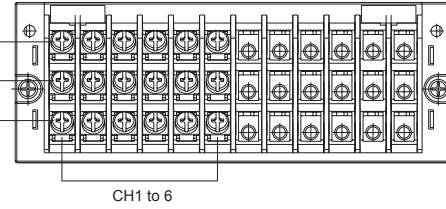

● Digital input

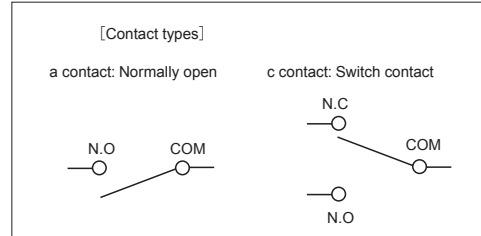
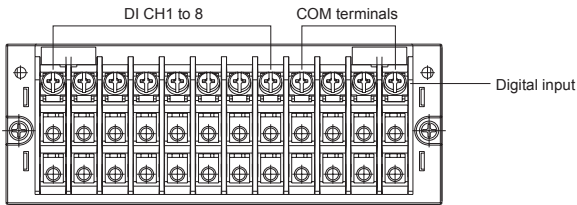

■ DIMENSIONS

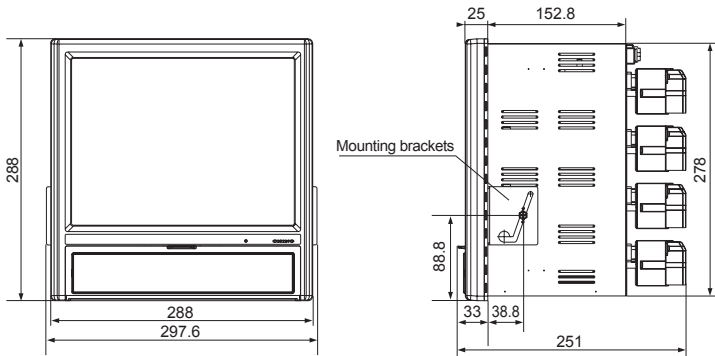

Unit: mm

● Panel cutout and minimum clearance

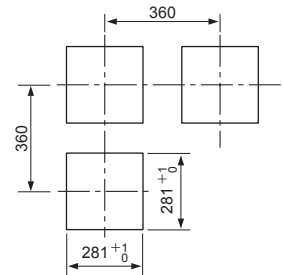

Unit: mm

Specifications subject to change without notice. Printed in Japan (I) 2020. 3

CHINO CORPORATION

32-8 KUMANO-CHO, ITABASHI-KU, TOKYO 173-8632

Telephone : +81-3-3956-2171

Facsimile : +81-3-3956-0915

E-mail : inter@chino.co.jp

Website : www.chino.co.jp/